

CUSTOMER'S NAME

Akizuki Denshi Tsusho Co., Ltd.

ALPHA REFERENCE NO.

SP20090097



SPECIFICATION

| PART NO. | ALPHA MODEL NAME |
|----------|-------------------------------|
| | SR10010F-0204-15K0A-C7-N-0027 |
| | |
| | |
| | |
| | |

MODEL NAME

MODEL NO.

APPROVAL

| PREPARED BY | REVIEWED BY | APPROVED BY |
|--|--|--|
|  2020.9.24 彩霞 |  2020-9-25 延玲 |  2020.9.25 祖衛 |



台灣艾華電子工業股份有限公司

33045 桃園市桃園區中正路 1221 號 9 樓

TAIWAN ALPHA ELECTRONIC CO., LTD.

9F, No. 1221, Chung Cheng Rd., Taoyuan Dist., Taoyuan City, 330 Taiwan

Tel: 886-3-3577799 Fax: 886-3-3577700

EMAIL: sales@taiwanalpha.com.tw

URL: http://www.taiwanalpha.com

ROTARY SWITCH



MODEL SR10010F-0204-(L)K0A-C7-N-0027

SPECIFICATIONS

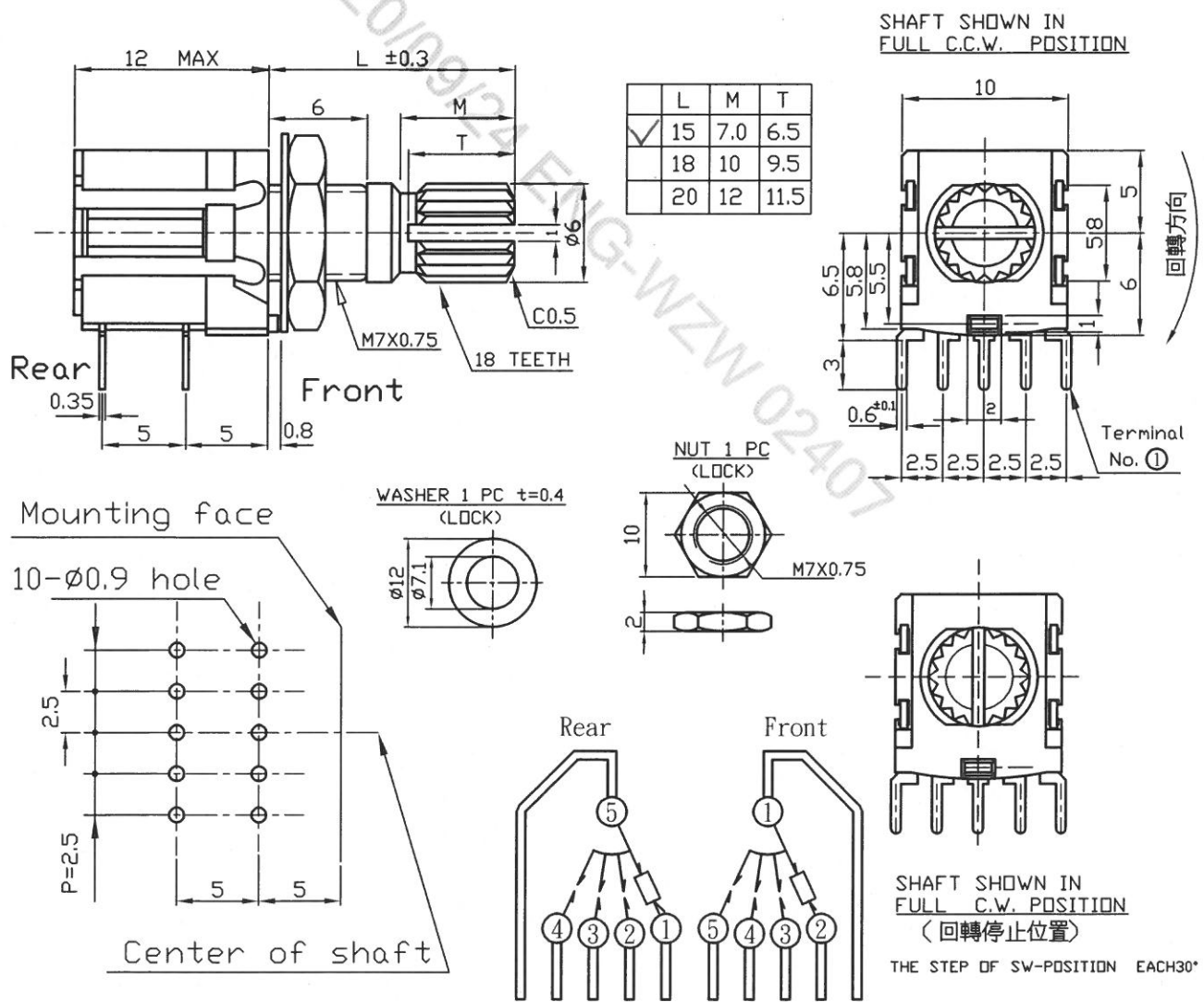
| | |
|-----------------------|-----------------------|
| Rating | DC 16V 0.1 A |
| Contact Resistance | 50 mΩ Max. |
| Insulation Resistance | DC100V-100 MΩ Min. |
| Withstand Voltage | AC100V-1 Minute |
| Operating Force | 400±200 gf.cm |
| Life cycle | 10,000 cycles |
| Sizes (m.m.) | As Following Drawings |



NOTE: 1. TOLERANCES UNLESS OTHERWISE SPECIFIED: ±0.3mm, angle: ±5°
2. ACCESSORY PARTS: ∅7 HEXAGON NUT ONE PIECE & WASHER ONE PIECE

| | | | | | | |
|------|------------|-----|--|------|-------|--|
| Date | 2020.09.24 | DWN |  2020.09.24 韋祖衛 | CHKD | APP'D |  2020.09.24 韋祖衛 |
|------|------------|-----|--|------|-------|--|

| | | |
|---|---|--------------------------------------|
|  | Specification Rotary switch SR10010F | DOC. No: Rev. A |
| | | Date: |
| | | Author: 何建志 |
| | | Approved: 王茂松 |

CONTENTS 内容

| Section | Description | Page |
|---------|------------------------|------|
| 1.0 | Test Conditions | 2 |
| 2.0 | Outside Dimension | 2 |
| 3.0 | Mechanical Performance | 2 |
| 4.0 | Electrical Performance | 3 |
| 5.0 | Endurance Performance | 3 |
| 6.0 | Note | 4 |

| | | |
|---|--|--------------------------------------|
|  | Specification Rotary switch SR10010F | DOC. No: Rev. A |
| | | Date: |
| | | Author: 何建志 |
| | | Approved: 王茂松 |

1. TEST CONDITIONS

Standard test conditions shall be 5-35°C in temperature and 45-85% RH in humidity.
Should any doubt arise in judgment test shall be conducted at 20±2°C and 65±5% RH.

2. OUTSIDE DIMENSION

Append drawing.

3. MECHANICAL PERFORMANCE

| Item | Test Condition | Specification |
|-----------------------|--|---|
| 3.1 Operating force | Operation temperature:-10°C ~ +70°C Storage temperature:-40°C ~ +85°C | 400±200gf-cm |
| 3.2 Control strength | A static load of 1000gf-cm shall be applied in the operating direction and tensile direction of the unit for one minute. | N/A |
| 3.3 Terminal strength | A static load of 500gf-cm shall be applied to the tip of the terminal in a desired direction for one minute. The number of tests shall be one per terminal. | N/A |
| 3.4 Control wobble | Shall be measured by applying a static load of 100gf-cm to the tip of control unit. | Less than 1 mm |
| 3.5 Soldering | Regarding preheating, the entire flow duration should not exceed 2 minutes, and soldering surface temperature (undersurface of PCB) shall be settled within 100°C. Temperature of solder 260±5°C Duration of dipping 4±0.5 seconds | More than 90% of the dipped part shall be covered by solder |

| | | |
|---|--|--------------------------------------|
|  | Specification Rotary switch SR10010F | DOC. No: Rev. A |
| | | Date: |
| | | Author: 何建志 |
| | | Approved: 王茂松 |

3.6 Soldering heat resistance Flow soldering condition: No abnormalities shall be observed in appearance and operation shall be assured.

to be performed in 4±0.5 seconds within 260±5°C

Manual soldering condition: to be performed in 3±0.5 seconds Max within 350±5°C

4. ELECTRICAL PERFORMANCE

| Item | Test Condition | Requirement |
|---------------------------|--|----------------------------------|
| 4.1 Rating | N/A | DC16V 0.1A |
| 4.2 Contact resistance | Shall be measured at 1KHz±200Hz (Max 20mV, Max 50mA) or 5V DC, 1A by a voltage drop method | Less than 50mΩ |
| 4.3 Insulation resistance | Shall be measured by applying 100V DC, between all terminals and between the terminal and the frame for 1 minute ± 5 seconds | More than 100MΩ |
| 4.4 Withstand voltage | 100V AC (50~60Hz, 2mA) Shall be applied between all terminals and between the terminal and frame for one minute | No function damage or breakdown. |

5. DURABILITY

5.1 Operating life under no load 10,000 cycles of operation shall be performed continuously at a rate of 15-20 cycles per minute without load. After operating life test, shall be in accordance with the following specifications.

Contact resistance: less than 80mΩ
Insulation resistance: more than 50MΩ
Withstand Voltage: 100V AC per one minute
Operating force: less than +10%,-30% for initial operating force

| | | |
|---|--|-----------------------|
|  | Specification Rotary switch SR10010F | DOC. No: _____ Rev. A |
| | | Date: _____ |
| | | Author: 何建志 |
| | | Approved: 王茂松 |

5.2 Operating life under load

10,000 cycles of operation shall be performed continuously at a rate of 15-20 cycles per minute with resistive load of 16V DC, 0.1A
After operating life test, shall be in accordance with the following specifications.

Contact resistance :
less than 150mΩ

Other specifications are the same as operating life under no load.

6. NOTE

Terminals top side is covered by flux resist resin.

ALPHA 2020/06/22 ENG-013 DG15672

無鉛焊錫與保管條件共通規格書

Common Specification of Lead-Free Soldering and Storage conditions

以下焊錫條件以可變電阻置於單層 1.6mm 厚度之印刷電路板上測試為基準。

The specification below is based on testing results of 1.6mm thickness single layer printed circuit board.

1. 自動或半自動機台焊錫條件：

For Automated or Semi-Automated Soldering Equipments:

1.1 使用發泡式且比重 0.82 以上的助焊劑，發泡高度以印刷電路板厚度一半為標準，且助劑不能流入可變電阻基板表面及印刷電路板表面。

Flux of 0.82 specific gravity, applied by foam fluxer, shall be used. Foam head shall be limited to the height which is half thickness of printed circuit board to be soldered. No flux should be allowed to run up onto resistive element board of potentiometer and the surface of printed circuit board.

1.2 預熱時間不超過兩分鐘，焊錫接面（即印刷電路板底）最高預熱溫度不超過 100°C。

Regarding preheating, the entire flow duration should not exceed 2 minutes, and soldering surface temperature (undersurface of PCB) shall be settled within 100°C.

2. 手工焊錫、自動或半自動機台焊錫不得超過一回。

Regardless of soldering facility and method, solder dipping or solder smearing must not be carried out more than 1 time.

2.1 焊錫注意事項：

Caution for soldering:

如圖所示，請避免 PCB 上層表面有焊錫

Please avoid soldering on upper surface of P.C.B. as shown.

3. 保管條件(Storage conditions):

產品需儲存在原始的包裝,以及保持常溫常濕、避免陽光直射、遠離任何腐蝕性氣體,產品需盡快完全地使用完,建議最慢不要超過交貨後 6 個月。產品經拆封後,全部的數量都需迅速地使用完。

The products shall be stored in the original packaging and kept at room temperature and humidity, out of direct sunlight, and away from any and all corrosive gas. The products shall be completely used as soon as possible, but no longer than 6 months from the date of delivery. Once product packaging is opened, the complete quantity of such products shall be promptly used.

